

THORN
LIGHTING



AREA FLOOD PRO

Application-versatile floodlight family
with advanced optical performance

ADVANCED OPTICAL PERFORMANCE

The optimised second-generation Areaflood Pro family was developed with Dark Sky sensitive principles in mind. All optics provide exceptional performance whilst minimising spill light. To ensure maximum comfort of users and neighbouring residents, Areaflood Pro offers 0 % ULOR when mounted at 0 degrees, safeguarding the night-time environment and reducing light pollution.

ROBUST LUMINAIRE DESIGN

Advanced optics are integrated within a robust and maintenance-free luminaire design. Areaflood Pro uses the highest quality materials for optimum lifetime performance and resistance to the toughest application environments. Featuring a rated lifetime of up to 100,000 hours (L95) and tested to C5 corrosion resistance.

FAMILY FLEXIBILITY

Areaflood Pro is a full family of functional floodlights, offering five sizes ranging from 4000 to 100,000 lumens, each with multiple light distributions to suit a wide range of applications and 21 light distribution variants in total. The slimline, lightweight design that each Areaflood Pro follows helps to ensure an easy installation and allows for a quick replacement onto existing columns and therefore reduces structural costs.



Recreational Sports



Swimming Pools



Industry



Logistics



Transportation



Car Parks



Building Surrounds

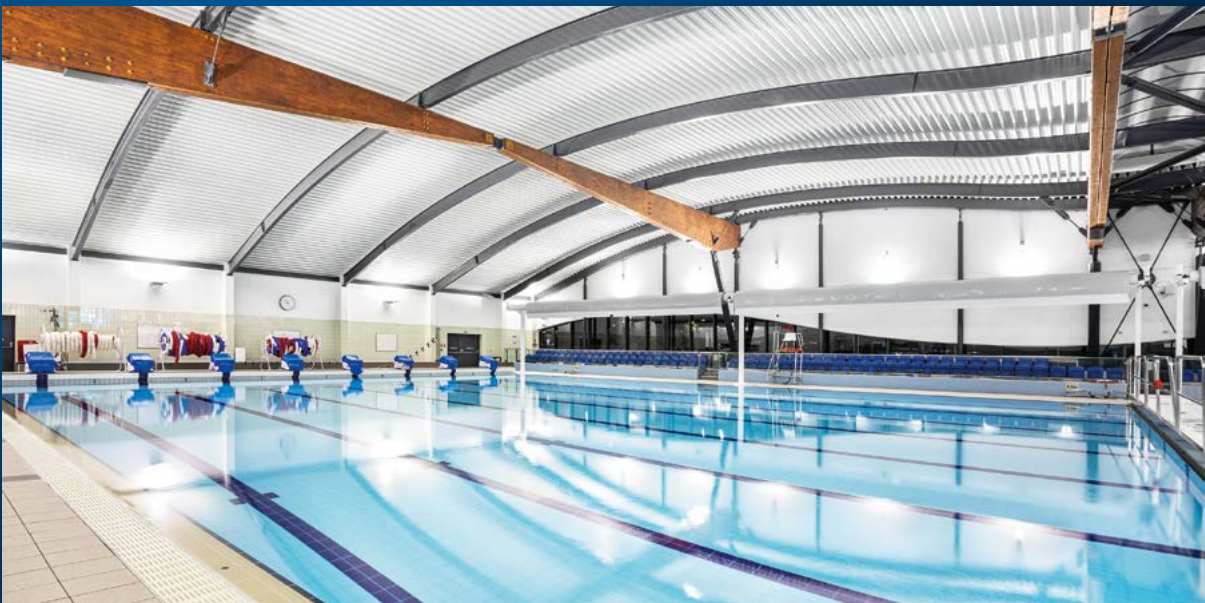

RENOWNED FOR REFURBISHMENT

AREAFLOOD PRO CREATES AN EASY AND LOW COST REFURBISHMENT OPPORTUNITY TO IMPLEMENT A SUSTAINABLE LIGHTING SOLUTION

Existing 1kW metal halide floodlights installed in recreational sports applications can be replaced on a point-for-point basis with Areaflood Pro. With no need to upgrade existing mounting poles due to Areaflood Pro's lightweight luminaire design and up to 100,000 lumen output.

TODAY'S ADVANCEMENT



Lumen
Up to 100,000 lm



Efficiency
Up to 180 lm/W



Windage
From SCx 0.052



UrbaSens
Full range of connected solutions



Optics
21 unique optics with 7 dedicated to sports applications



Ease of Installation
On board driver accessible with single tool

In applications where 1kW metal halide are installed, the new Areaflood Pro floodlight offers a fantastic connected upgrade opportunity with sufficient outputs for applications such as transportation spaces, building surrounds and large car parks.

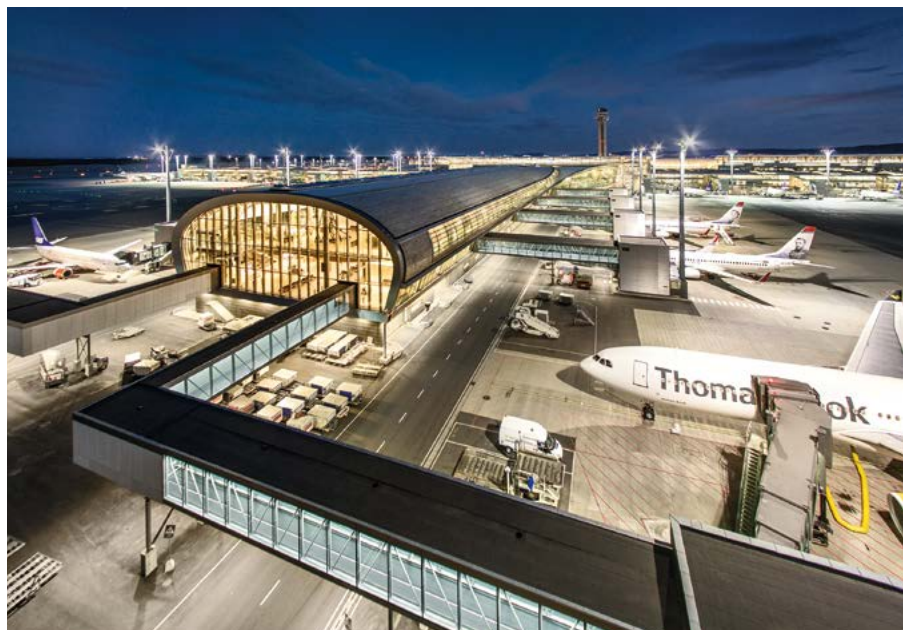

THE AREA FLOOD PRO FAMILY

FULL PACKAGE FUNCTIONAL FLOODLIGHT FAMILY,
WITH A VARIETY OF OPTIONAL ACCESSORIES TO
CREATE A TAILOR-MADE SOLUTION



Small
Up to 16,000 lm



Medium
Up to 37,000 lm



Large
Up to 53,000 lm

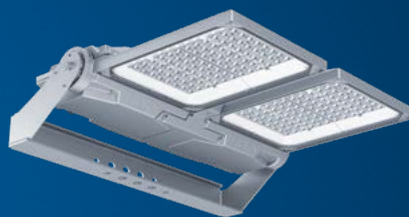

Double Medium
Up to 75,000 lm

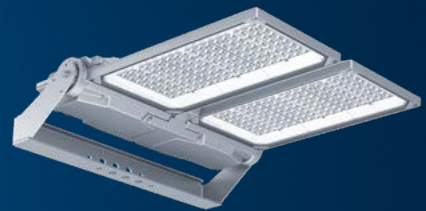

Double Large
Up to 100,000 lm

ACCESSORIES



AIMING DEVICE
Ease of on-site luminaire focusing to ensure the design intent is realised.



LOUVRE
The ideal accessory for additional light spill management.



JUNCTION BOX
Allows the connection of multiple luminaires via through wiring.



BIRD DETERRENT
Prevent birds from landing on and damaging the floodlight.



PROTECTIVE GRILL
Accessory for additional protection in hazardous environments.

URBASENS CONTROL AND CONNECTIVITY

AS TECHNOLOGY INNOVATORS, THORN LIGHTING HAS A VARIETY OF APPLICATION SPECIFIC CONNECTIVITY SOLUTIONS

Uniform standards such as Zhaga, enables interoperability and upgradability for light points over time. Areaflood Pro has been designed to maximise the opportunity to responsibly and dynamically control light levels.

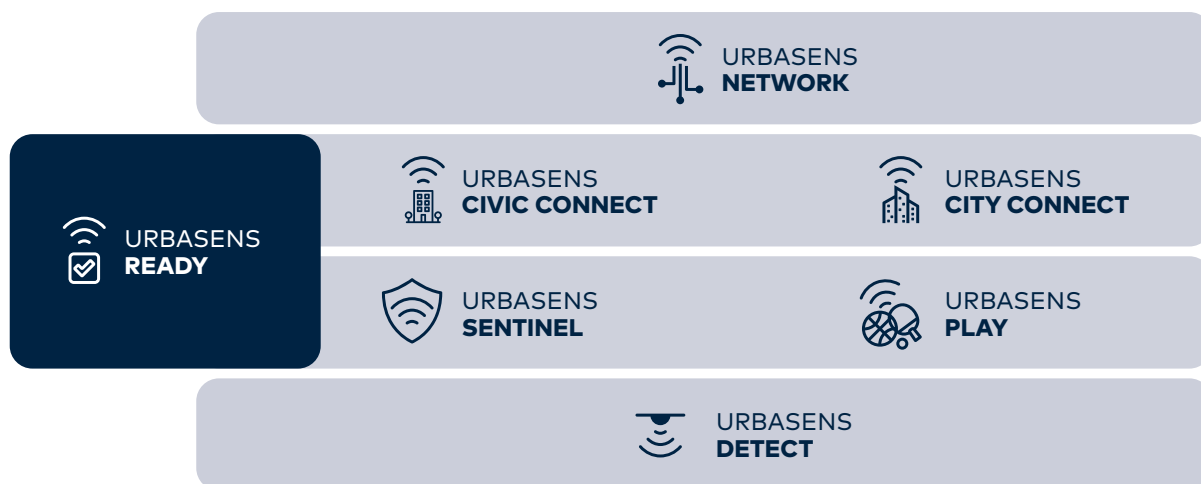

URBASENS CIVIC CONNECT

Using the latest cellular technology, UrbaSens CIVIC CONNECT is a remote access Central Management System connectivity solution. A key benefit of UrbaSens CIVIC CONNECT is the data analytics offering from a TALQ platform. This means that through your Areaflood Pro luminaires, you get a visual of your CO₂ reduction, energy consumption, usage and a heat map view of activity in the space.



URBASENS PLAY

The connected solution for recreational and training sports applications including MUGA (Multi Use Games Area). Via Bluetooth® connectivity and a physical control panel, UrbaSens Play offers application flexibility and supports your need to reduce overall energy consumption.



URBASENS SENTINEL

Developed for building surrounds, car parks as well as transportation spaces, UrbaSens SENTINEL allows Areaflood Pro to be adapted to the weekly scheduling of the application. Combined with motion detection, the lighting constantly adapts to the usage of the space, ensuring light is only applied where and when it is needed for a fully autonomous and sustainable solution.



URBASENS READY

Future-proof your Areaflood Pro installation by specifying luminaires with a connected driver as well as Zhaga Up/Down or Nema sockets. Ready to plug in a control node for a fully connected solution.

DISCOVER

AREAFLOOD PRO

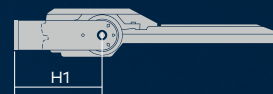
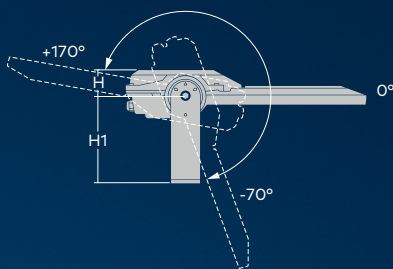
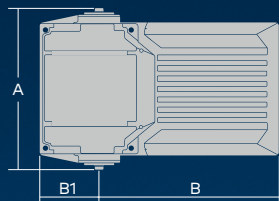

	A (mm)	B (mm)	B1 (mm)	H (mm)	H1 (mm)	(Kg)	SCx (at 0°)
S	375	285	145	62.5	208	7.6	0.052
M	389	435	145	62.5	208	10.6	0.060
L	389	585	145	62.5	232	13.9	0.068

	SMALL (S)	MEDIUM (M)	LARGE (L)
	Up to 48 LEDs	Up to 96 LEDs	Up to 144 LEDs
	2700 K, 3000 K, 4000 K, 5700 K, Balanced White (2700 K – 5700 K)		
	4000 to 16 000 lm	10 000 to 37 000 lm	18 500 to 53 000 lm
	up to 175 lm/W	up to 178 lm/W	up to 180 lm/W
	27 to 101 W	62 to 245 W	109 to 337 W
CRI	70 / 80 / 90 / TLCI86 / TLCI90		
	IP66		
	-25 °C to 50 °C		
	IK08		
	up to L95 100 000 h		
	14 optics for road and area lighting + 7 optics for intensive or asymmetric sport lighting		
	Fixation of the product using a stirrup with different inclination angle and fixation points		
	Light grey close to RAL9006 and 50 additional RAL colours		
	DALI dimmable (HFX) / Bi-Power Line (BPL) / Bi-Power Switch (BS) / Constant Light Output (CLO) / Light Reduction Twin / UrbaSens		
	Indoor Swimming Pool (SWP) variants available		



AREAFLOOD PRO

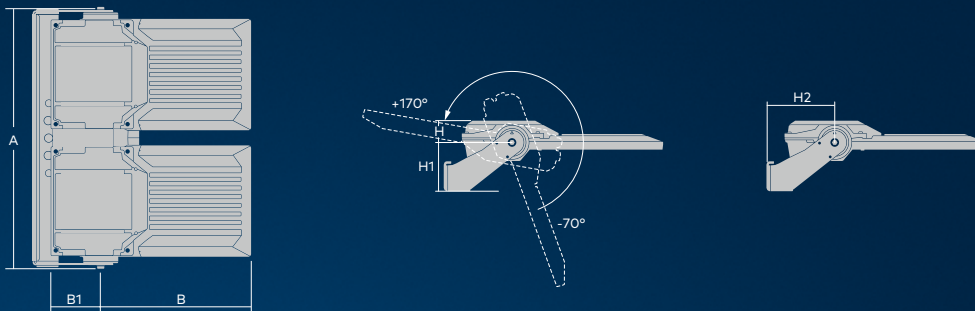

	A (mm)	B (mm)	B1 (mm)	H (mm)	H1 (mm)	H2 (mm)	(Kg)	SCx (at 0°)
2M	753	435	145	62.5	142	195	24.5	0.120
2L	753	585	145	62.5	142	195	29.2	0.136

	DOUBLE MEDIUM (2M)	DOUBLE LARGE (2L)
	Up to 192 LEDs	Up to 288 LEDs
	2700 K, 3000 K, 4000 K, 5700 K, Balanced White (2700 K – 5700 K)	
	46 000 to 75 000 lm	52 000 to 100 000 lm
	up to 172 lm/W	
	276 to 483 W	411 to 638 W
CRI	70 / 80 / 90 / TLCI86 / TLCI90	
	IP66	
	-25 °C to 50 °C	
	IK08	
	up to L95 100 000 h	
	14 optics for road and area lighting + 7 optics for intensive or asymmetric sport lighting	
	Fixation of the product using a stirrup with different inclination angle and fixation points	
	Light grey close to RAL9006 and 50 additional RAL colours	
	DALI dimmable (HFX) / Bi-Power Line (BPL) / Bi-Power Switch (BS) / Constant Light Output (CLO) / Light Reduction Twin / UrbaSens	
	Indoor Swimming Pool (SWP) variants available	



As a globally leading luminaire manufacturer, Thorn Lighting provides a five-year warranty for its complete product range within all European Countries.
thornlighting.com/guarantee

Thorn Lighting is constantly developing and improving its products. All descriptions, illustrations, drawings and specifications in this publication present only general particulars and shall not form part of any contract. The right is reserved to change specifications without prior notification or public announcement. All goods supplied by the company are supplied subject to the company's General Conditions of Sale, a copy of which is available on request. All measurements are in millimetres and weights in kilograms unless otherwise stated.
10/2023 (INT)

**WE
MAKE
LIGHT
WORK**