

THORN
LIGHTING



AQUAFORCE PRO

Durable and chemical resistant waterproof luminaire
with advanced connectivity

PUTTING THE 'PRO' IN WATERPROOF

Aquaforce Pro sets the standard when it comes to durability of waterproof luminaires. Available in a choice of two materials; Polycarbonate (PC) or Polymethyl Methacrylate (PMMA), it's a versatile luminaire that can be used in range of demanding environments.

An IP66 certified resistance to water, dust and dirt, as well as a tough shock-resistant IK08 body mean Aquaforce Pro is well suited to multiple applications including industry, logistics, indoor car parks and back of house.

Not only that, Aquaforce Pro is easy to install. There are multiple conduit entry points, it's suitable for wall or ceiling mounting, has a tool-free cable terminal block, an easy-click diffuser and sliding mounting brackets.

With connectivity options, Aquaforce Pro can enhance spaces through presence detection and offer additional energy and cost savings.



Industry



Manufacturing



Logistics



Food Processing



Car Parks



Storerooms



Back of House

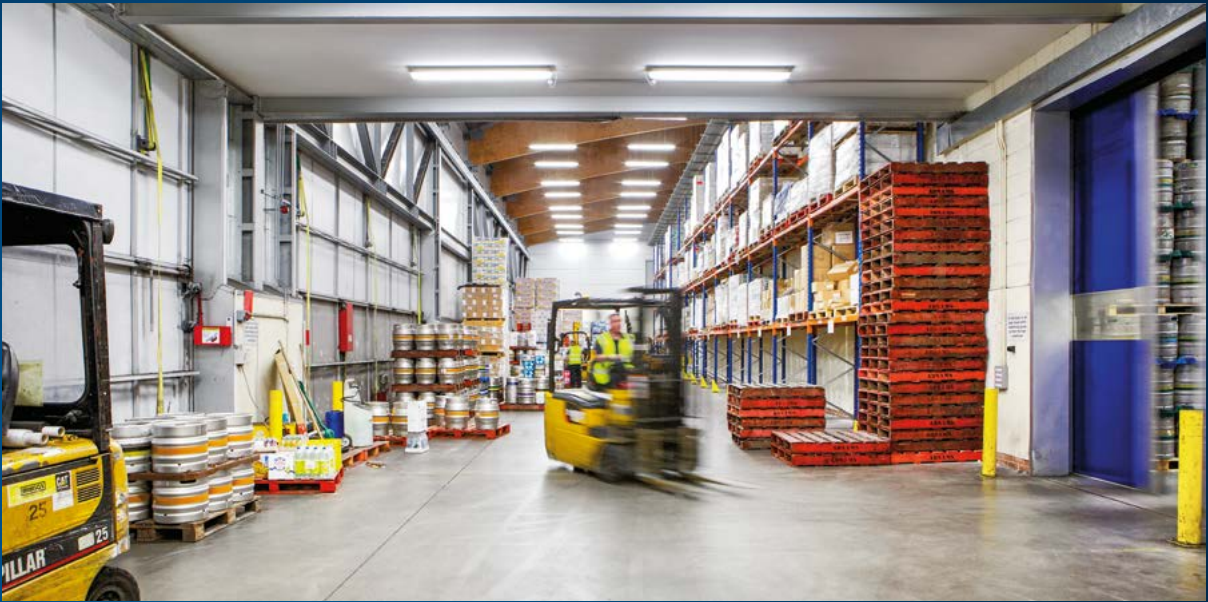
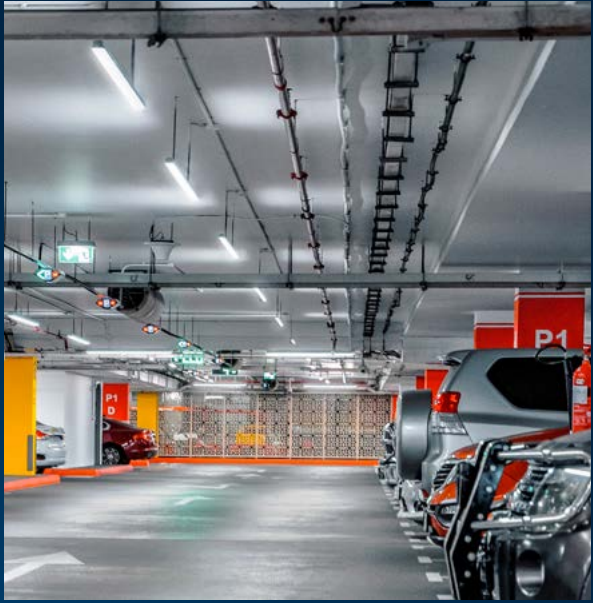

AQUAFORCE PRO

THE VERSATILE WATERPROOF AND IMPACT RESISTANT LUMINAIRE WITH WIRELESS CONNECTIVITY

With Aquaforce Pro, you can rely on unprecedented performance and versatility. The IP66-rated fitting is available in a choice of wide and medium beam light distributions tailored for demanding environments. Its diffuser ensures best light quality and is perfectly adapted for the DIN 67528 parking standard.

Moreover, Aquaforce Pro features DALI dimming and a built-in corridor function, using a presence detector to dim down and turn off automatically when circulation areas are not in use. Aquaforce Pro is your ideal choice for retrofit and refurbishment projects. With an efficacy as high as 167 lm/W, the potential savings are significant. Unlike some LED luminaires that struggle to match the light output of conventional products on a one-for-one basis, Aquaforce Pro delivers the performance you need with up to 10,000 lumens.



TAILORED LIGHT DISTRIBUTION

Cutting-edge light transmission technology: a combination of refraction prisms and scattering agents distribute the light over a wide angular range. It provides uniform light without sharp edges, and a high level of light transmission, for maximum efficacy.



RESISTANT TO WATER, DUST, DIRT, EXTREME TEMPERATURES AND IMPACT

This robust polycarbonate (PC) luminaire is resistant to the elements, with its high IP66 and IK08 rating. Built to resist extreme ambient temperatures ranging from -20 °C to 45 °C. The polymethyl methacrylate (PMMA) version is designed for chemical and UV resistance at ambient temperatures of -10 °C to 35 °C. Its clever drip-edge design avoids dust depositing on the light output surface.

THORN WATERPROOF CONNECTED FAMILY

Aquaforce Pro, ForceLED and Escort all have optional smart connectivity. This enables wireless communication between luminaires thanks to the basicDIM modules and controller app built on Bluetooth® mesh technology.

15 m

Maximum spacing between luminaires

20 m

Maximum distance between luminaire and mobile devices running application

250

Maximum nodes on one network

∞

Maximum number of networks: unlimited



SIMPLE MOUNTING

Aquaforce Pro is simple to install, use and maintain. Technical features such as mounting sliders, EasyClick diffuser system and the 10 conduit entry points all provide a high level of installation flexibility often required on site. Aquaforce Pro is suitable for wall mounting, both vertically and horizontally, and allows a tool-free installation on trunking systems.

INSTALLATION

01



Positioning

02



Fixing

03



Mounting sliders

04



EasyClick

AQUAFORCE PRO

THE PRODUCT AT A GLANCE

Aquaforce Pro is available in two materials:

PC: UV and high impact resistance; chemical resistance to alcohol, ethanol and water.

PMMA: High lighting transmission; resistant to shocks, weather influences and UV radiation; minimised risk of stress cracking; chemical resistance to a wide range of acids.

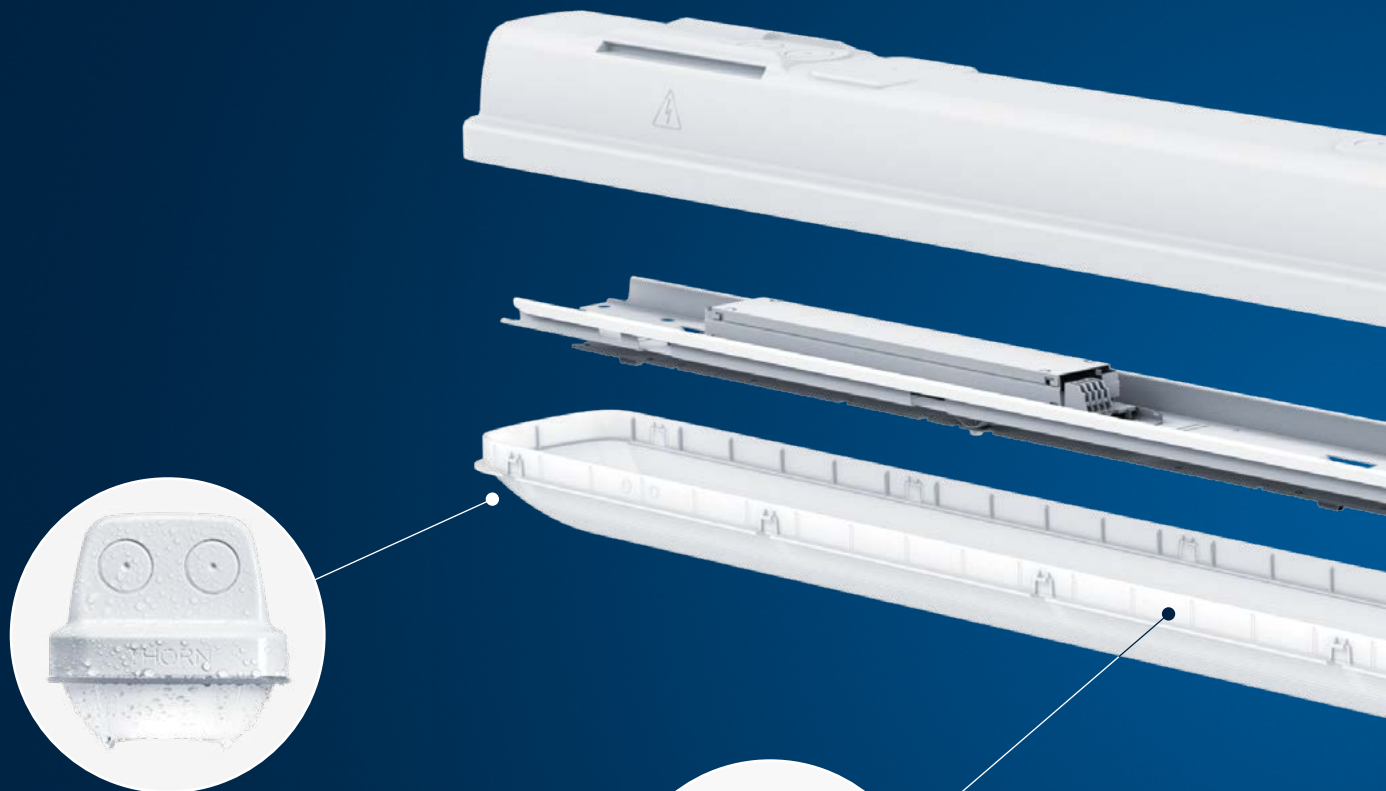

DRIP-EDGE EFFECT

Unique design with drip-edge effect to avoid dirt build up on the main surface of the luminaire

EASYCLICK

Patented snap-on mechanism for clipless mounting of diffuser

SENSOR CONTROL



Aquaforce Pro is configurable with a range of sensor and control options including Microwave presence sensor (MWS), basicDIM Bluetooth Wireless (BC), Microwave presence sensor and basicDIM Bluetooth Wireless (MWBC) and Microwave presence sensor and basicDIM Bluetooth Wireless with Corridor Function (MWCFCB)

OPERATING TEMPERATURES



-20 °C up to 45 °C (PC)
-10 °C up to 35 °C (PMMA)



SIMPLE MOUNTING

Long mounting sliders offer high flexibility during installation

QUICK-CONNECT

Equipped with quick-fit electrical connection (PC version only)

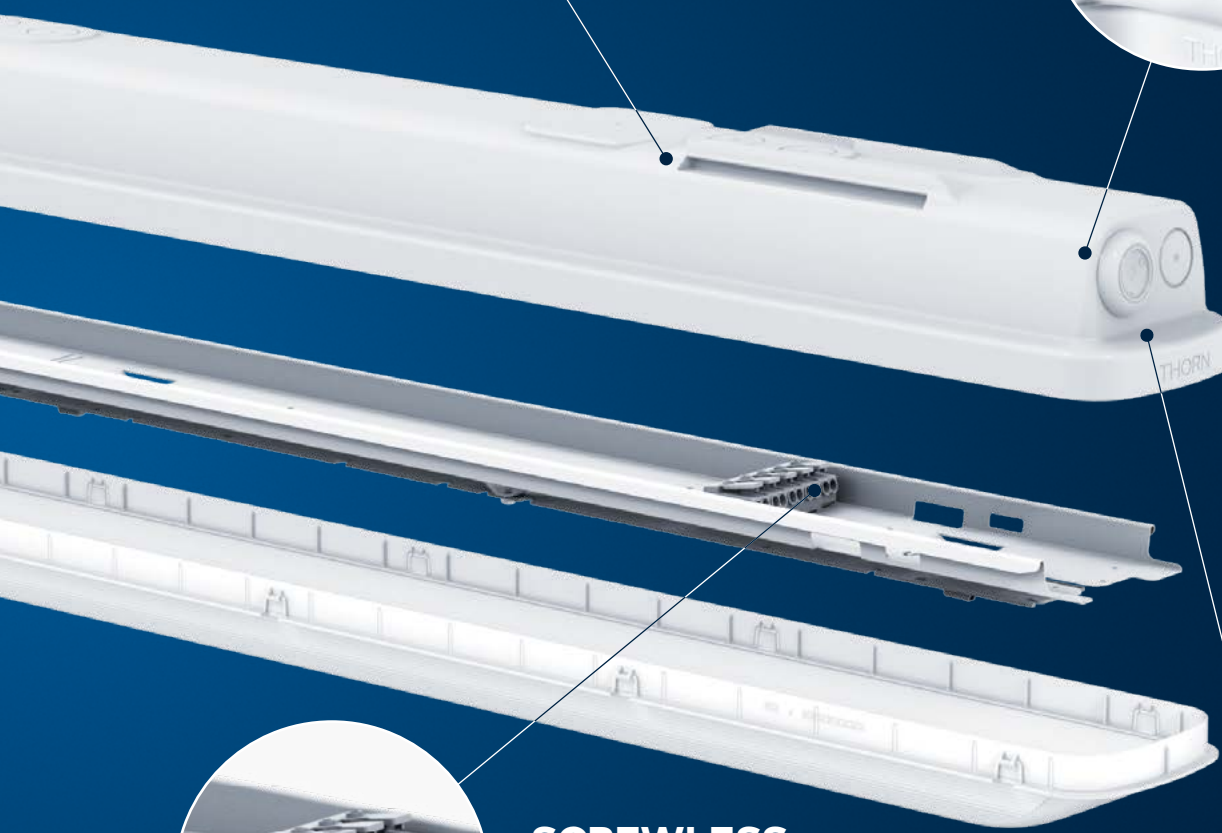

SCREWLESS CABLE TERMINAL

For faster wiring



TWO LENGTHS

1100 or 1600 mm versions

DRILL HOLES FOR CABLE ENTRIES

10 cable entry options at 5 different positions for through-wiring

DISCOVER

www.thornlighting.com/AQUP

AQUAFORCE PRO

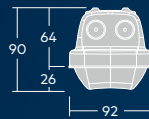

PC

PMMA



DALI dimmable
S: 2900 lm, 4300 lm, 5200 lm
L: 4300 lm, 6400 lm, 8000 lm, 10 000 lm



Up to 167 lm/W



3000 K / 4000 K



> 80



IK08

IK03



-20 °C to 45 °C

-10 °C to 35 °C



100 000 h L80@25 °C

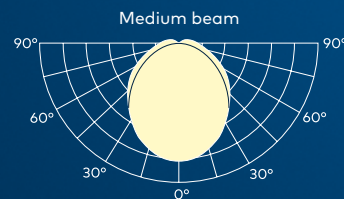
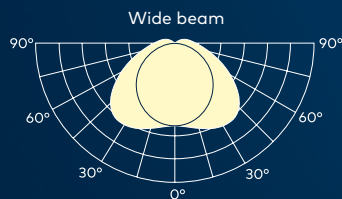

Fixed output (HF), DALI (HFI), Microwave Presence Sensor (MWS),
Microwave Presence Sensor with Corridor Function (MWCF), basicDIM Bluetooth® Wireless (BC),
Microwave Presence Sensor and basicDIM Bluetooth® Wireless (MWBC) and
Microwave Presence Sensor and basicDIM Bluetooth® Wireless with Corridor Function (MWCFCB)



3hr manual test, NiMH battery (E3)
3hr addressable self-test, NiMH battery (E3D, E3DUK)





MATERIALS

CHOOSING THE RIGHT MATERIAL FOR THE APPLICATION



Lighting in the food industry requires strong task illumination and uncompromising standards of hygiene. The working areas can be damp, corrosive and laden with oil and fat vapours. Specialised cleaning agents are used, which could damage or inhibit the performance of the luminaires. Aquaforce Pro with its PMMA body and diffuser overcome these issues and meet the tough regulations set by the HACCP and BRC food standards guidelines.



The challenge when mounting luminaires in racking or mezzanine areas are the dangers from moving vehicles, such as forklift trucks, that can collide with fittings and cause potentially disruptive vibration. Aquaforce Pro with its tough polycarbonate diffuser and body will resist a direct impact of up to IK08 and still perform.

CHEMICAL RESISTANCE OVERVIEW

Aquaforce Pro is available in PC & PMMA, Aquaforce in PC.

	PC	PMMA		PC	PMMA
Acetic acid <10 %	■	■	Hydrogen peroxide <10 %	■	■
Acetic acid >10 %	—	□	Hydrogen peroxide >10 % <30 %	■	■
Acetone	—	—	Hydrogen sulphide	—	—
Aliphatic hydrocarbons	■	■	Isopropyl alcohol	■	—
Ammonia <25 %	—	■	Ketones	—	—
Aniline	—	—	Lime milk	□	■
Aromatic hydrocarbons	—	—	Methanol	—	—
Beer	■	■	Methylene chloride	—	—
Benzene	—	■	Nitric acid <10 %	■	■
Benzine (cleaning spirit)	■	■	Nitric acid >10 % <20 %	□	■
Blood	■	■	Nitric acid >20 %	—	—
Bromic acid	—	—	Petroleum ether	□	■
Carbon dioxide gas	■	■	Phenol	—	—
Carbon monoxide gas	■	■	Potassium hydroxide <30 %	—	■
Carbon tetrachloride	—	■	Pyridine	—	—
Chloroform	—	—	Regular petrol	—	—
Chlorphenol	—	—	Seawater	■	■
Cresol	—	—	Saline solution	■	■
Diesel fuel	—	—	Soapsuds	■	■
Dioxane	—	—	Soda (sodium carbonate)	■	■
Ethanol <30 %	■	□	Sodium hydroxide solution <10 %	—	■
Ethanol >30 %	■	—	Spirit of turpentine	■	■
Ether	—	—	Sulphuric acid (H ₂ SO ₄) <30 %	■	■
Ethyl acetate	—	—	Sulphuric acid (H ₂ SO ₄) >30 % <50 %	■	—
Fats: animal	—	■	Sulphuric acid (H ₂ SO ₄) >50 %	—	—
Fats: mineral	—	■	Toluene	—	—
Fats: vegetable	—	■	Trichloroethane	—	—
Fuel oil	—	—	Water up to 60 °C	■	■
Glycerol	□	■	Xylene	—	—
Glycol	■	■			
Hydrochloric acid (HCL) <10 %	■	■			
Hydrochloric acid (HCL) >10 % <20 %	■	■			

CLEANING AGENTS, DISINFECTANTS AND COOLANTS

	PC	PMMA
ACMOSIL 37-5504	—	—
Coolants QUAKERCOOL 7200 HBF	—	□
Coolants QUAKERCOOL 7200 BFF	—	□
Coolants QUAKERCOOL 7100 HD	—	□
GORAPUR LI 2920-40 E	—	—
MV Quartacid plus from Schülke	■	■
MV Quartasept plus from Schülke	□	■
MV perform classic alcohol IPA from Schülke	■	■
P3-topactive OKTO (disinfectant; acid solution with peroxide) from ECOLAB	□	■
P3-topax 66 (cleaner/disinfectant; alkaline with chlorine) from ECOLAB	—	■
P3-topactive 200 (cleaner, alkaline with tenside) from ECOLAB	□	■
P3-topactive 500 (cleaner, acid solution with tenside) from ECOLAB	□	■
P3-topax 990 (neutral disinfectant; basic alkylaminacetat) from ECOLAB	□	■
PU-5408H, PU-1706M, PU-5421H, PU-4111M from Chem-Trend	—	—
PU-HS-Antiblock 6291/21, A-PU-Antiblock 6/428-5 from Bomix	—	—

DISCLAIMER: our recommendations concerning the chemical resistance of the materials are based upon information from material suppliers, careful examination of available published documents and our experience in different industry applications. However, since the resistance of metals, plastics and elastomers can be affected by the concentration, temperature, presence of various chemicals and other factors, the above datasheet should be considered as a general guide rather than an unqualified guarantee. Ultimately, the customer must determine the suitability of the luminaires in various solutions and applications.

■ Resistant □ Conditioned resistant — Not resistant

SMART CONNECTIVITY

Thanks to the optional basicDIM Bluetooth® Wireless module, you can now wirelessly connect lighting fixtures to each other or in groups. Thorn have a range of waterproof luminaires that can be controlled individually or in groups by presence or light sensors, and luminaires can even connect to each other wirelessly, for simple control without the need to install any new cabling.



COMMUNICATIVE

Thorn can offer basicDIM connectivity for Aquaforce Pro and our other waterproof luminaires ForceLED and Escort, plus the HiPak highbay. The luminaires can be grouped together into zones and configured to dim or simply switch on or off.

basicDIM Wireless is based on Bluetooth® Low Energy, a state-of-the-art wireless technology. basicDIM provides a Bluetooth® network where functionality is distributed across all nodes, ensuring a high level of connection reliability.

15 m

Maximum spacing between luminaires

20 m

Maximum distance between luminaire and mobile devices running application

250

Maximum nodes on one network

∞

Maximum number of networks: unlimited



FLEXIBLE

Conveniently configure your waterproof luminaire from your smartphone or tablet via password-protected Bluetooth® connection. basicDIM allows you to define various light profiles, both individually and as a group.



ADAPTIVE

Thorn waterproof luminaires are also available with a sensor that monitors movements over an area of 7.5 m when mounted at a height of 3 m. Via the app it is possible to adjust the sensitivity and the range.

WIRELESS CAPABILITIES



- 1 Aquaforce Pro (with basicDIM and Microwave Presence Sensor)
- 2 Aquaforce Pro (with basicDIM)
- 3 basicDIM Bluetooth® Wireless User Interface



APPLICATION EXAMPLE

ROOM

- x9 Aquaforce Pro
- x3 ForceLED
- x2 Escort

LIGHTING SOLUTION

- Switching on and off
- Dimming functions
- Grouping luminaires
- Integrate sensors

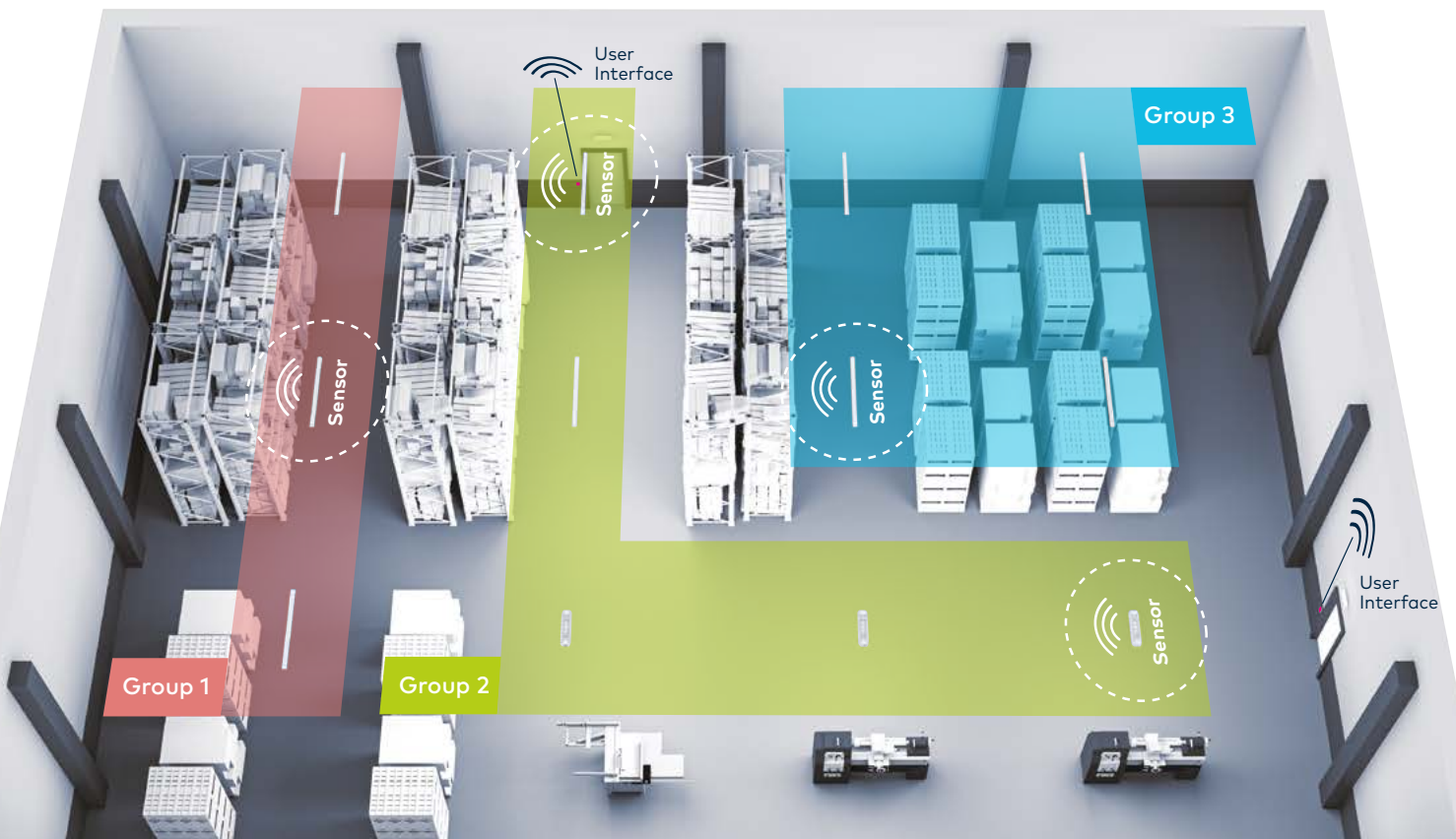

ENERGY SAVINGS & REFURBISHMENT

REFURBISHMENT PROJECT: UPGRADE A WAREHOUSE AREA

- Upgrade a warehouse by replacing the current T26 fluorescent fittings with Aquaforce Pro (LED)
- Improve the light quality and reduce errors in picking
- Warehouse is 10 m by 8 m with a ceiling height of 6 m
- In operation 7 days a week from 5am to 6pm
- Based on an energy cost of 26.6 (Eur/a)/kW¹
- Calculations are based on a 15 year lifetime
- The upgrade will replace 9 (2x70W) T26 Aquaforce II with 12 (62W) Aquaforce Pro 8000 lm
- With an energy reduction from 1260W to 744W, the return on investment will be less than 10 months
- 4,526 kg CO₂ reduction over lifetime

RETURN ON INVESTMENT WITHIN 10 MONTHS

- Original T26 Solution
- LED Solution (no controls)

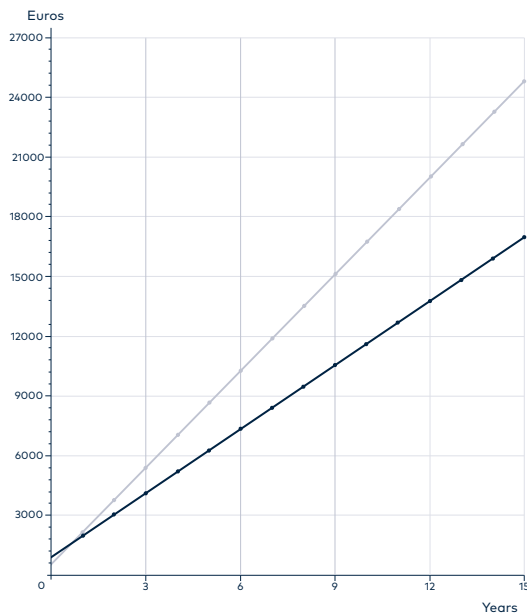

36 % ENERGY REDUCTION OVER LIFETIME

- Original T26 Solution
- LED Solution (no controls)

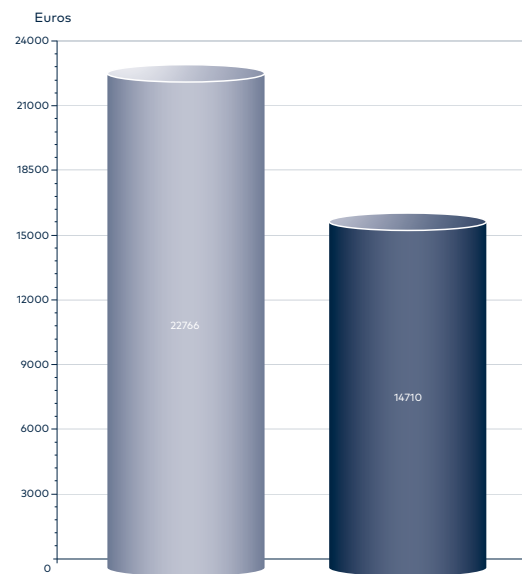

¹ Calculations made using Thorn ecoCALC software

Upgrade of a warehouse by replacing the current fluorescent fittings with Aquaforce Pro

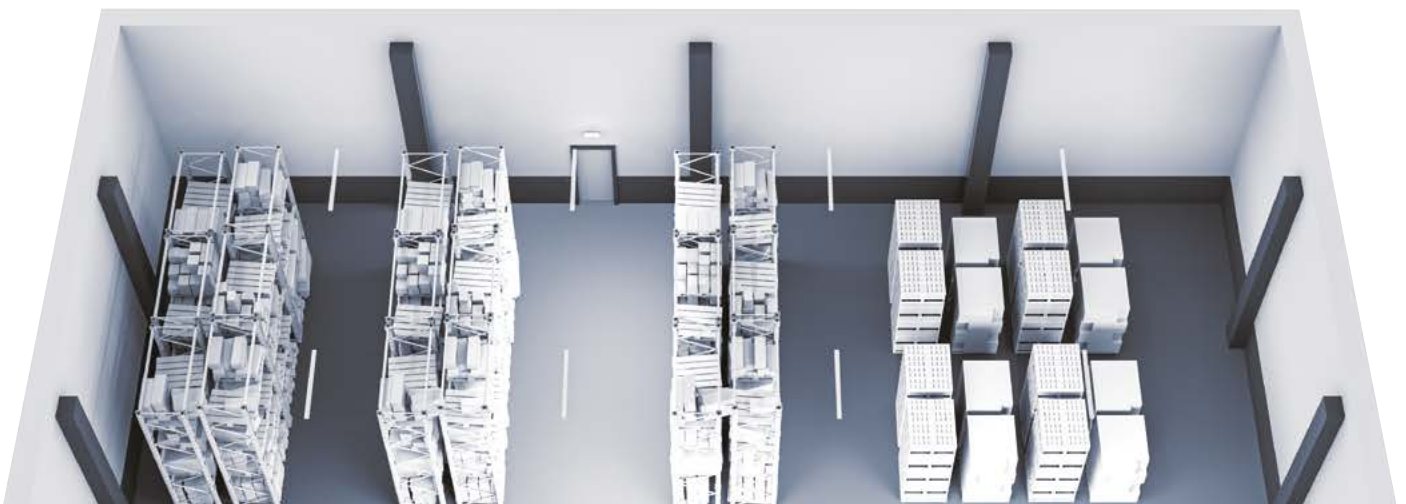

UPGRADING THE LIGHTING SOLUTION IN A WAREHOUSE USING AQUAFORCE PRO AND BASICDIM WIRELESS CONTROLS

- A bigger energy saving can be realised if a wireless controls system is installed into the same project
- Even though the initial investment will increase, the return-on-investment period will be less than 14 months due to the amount of energy savings that can be achieved
- Configuring the task area into zones and dimming to 10 % when the sensors are not activated will save around 70 % in energy costs over the lifetime compared to the original fluorescent fittings
- With controls 70 % CO₂ reduction is possible (29,981 kg CO₂ reduction over lifetime)
- Using basicDIM wireless control means that no additional wiring is required, saving on additional investment

RETURN ON INVESTMENT WITHIN 14 MONTHS

- Original T26 Solution
- LED Solution (with Wireless Controls)

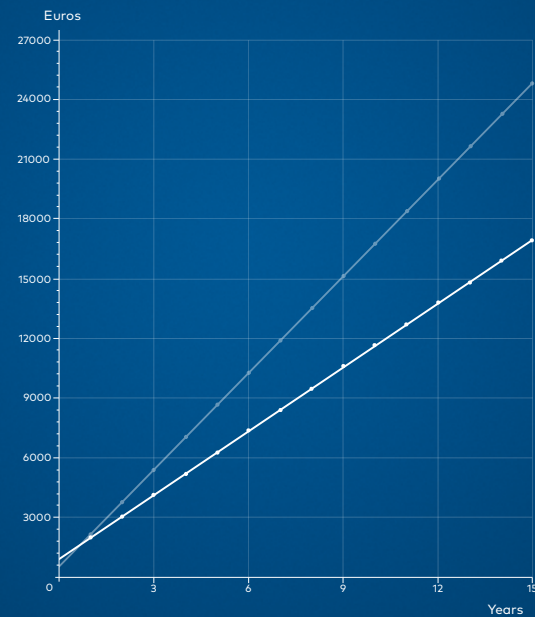

70 % ENERGY REDUCTION OVER LIFETIME

- Original T26 Solution
- LED Solution (with Wireless Controls)

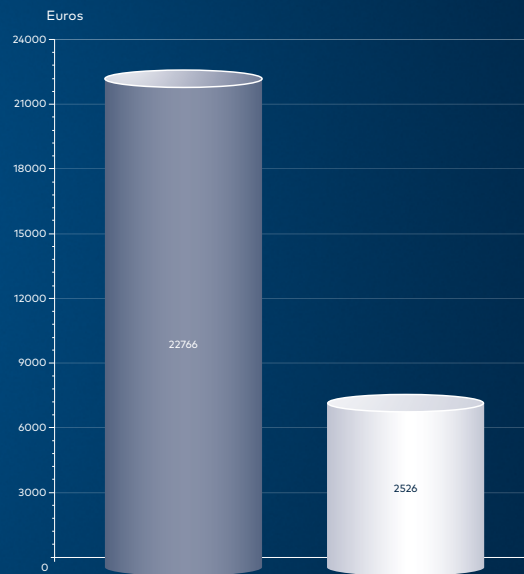

Upgrade of a warehouse by replacing the current fluorescent fittings with Aquaforce Pro and basicDIM wireless controls

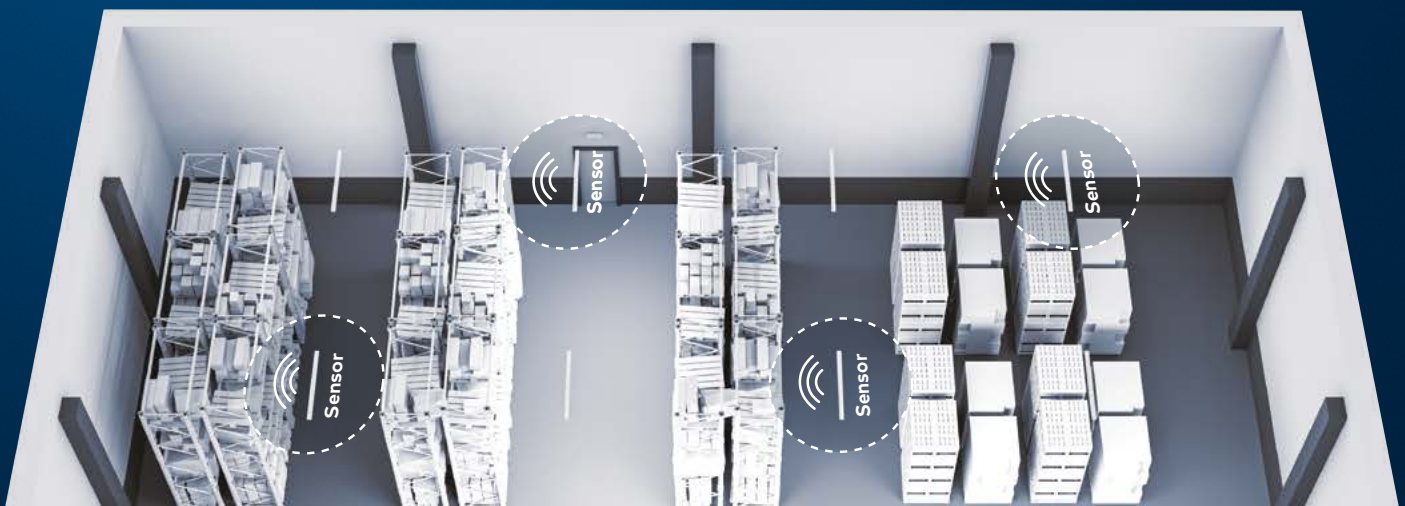

GET IN TOUCH

www.thornlighting.com/contact



**5 YEAR
GUARANTEE**

As a globally leading luminaire manufacturer, Thorn Lighting provides a five-year warranty for its complete product range within all European Countries.
thornlighting.com/guarantee

Thorn Lighting is constantly developing and improving its products. All descriptions, illustrations, drawings and specifications in this publication present only general particulars and shall not form part of any contract. The right is reserved to change specifications without prior notification or public announcement. All goods supplied by the company are supplied subject to the company's General Conditions of Sale, a copy of which is available on request. All measurements are in millimetres and weights in kilograms unless otherwise stated.
07/2023 (INT)

**WE
MAKE
LIGHT
WORK**