

LED Batten

LED Batten with homogenous light emitting surface and Vario Flex technology, IP20 for indoor applications. Total luminous flux: 2000 lm. Luminaire input power: 16 W. Luminaire efficacy: 125 lm/W. Colour rendering Ra > 80, colour temperature 3000/3500/4000 K, adjustable via switch. Lifetime: 50.000hrs @L80. Chromaticity tolerance (initial MacAdam): 5, Impact strength: IK08. FLEX technology allows to adjust the input power on site by 3 steps (FLEX1: 2000 lm (16W), FLEX2: 1500 lm (11W), FLEX3: 1000 lm (8W)). For flex data on other colour temperatures please visit website. Mounting directly onto ceiling or by using flexible mounting brackets for any fixing hole distance. Dimensions: 605 x 43 x 53 mm, weight: 0.4 kg.

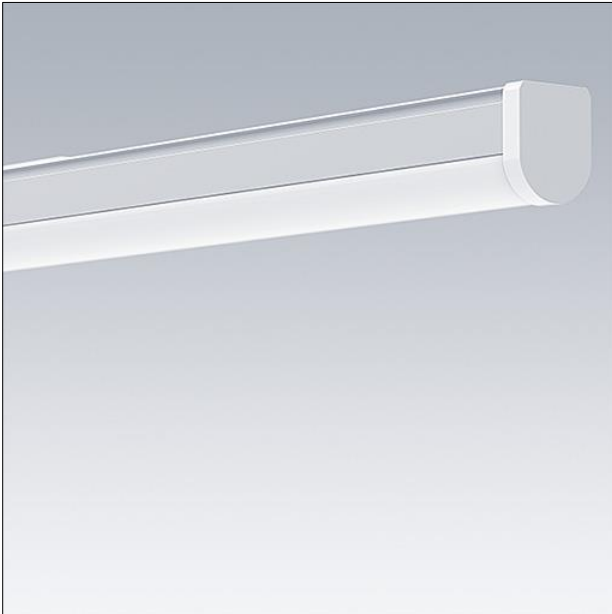

TE_EMMAVARIOFLEX_F.jpg

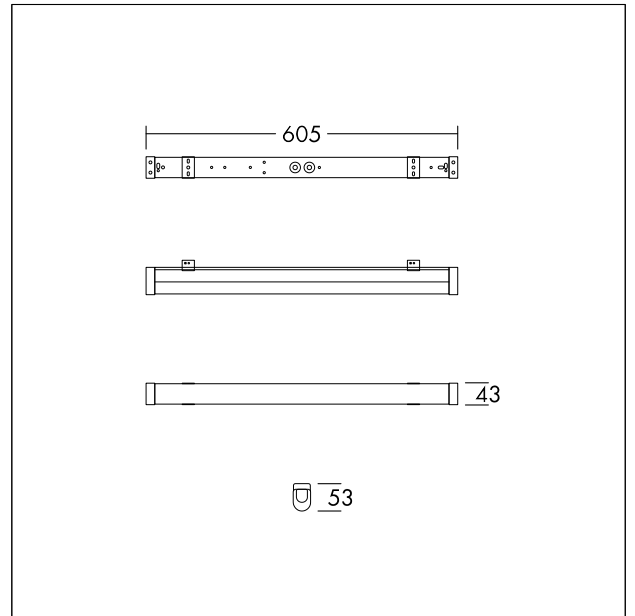

TE_EMMAVARIOFLEX_M_600.wmf

Light Distribution

STD - standard

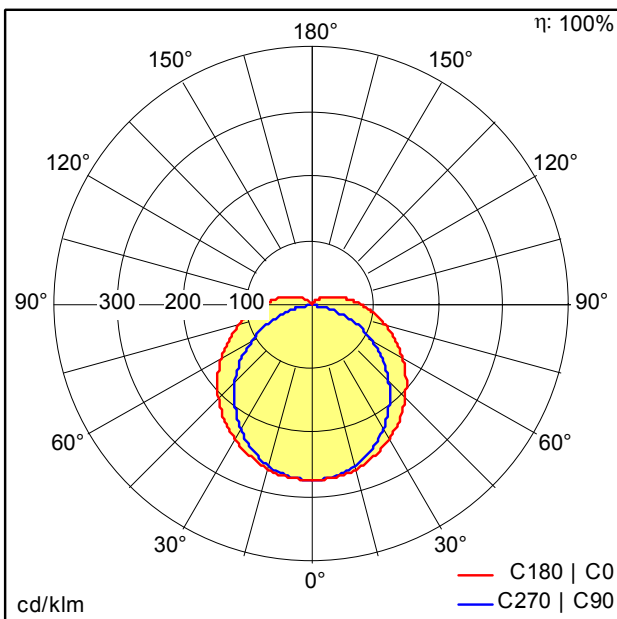

TE_EMMA_VARIOFLEX_600_2000_840_FLEX1.ltd

- Light Source: LED
- Luminaire luminous flux*: 2002 lm
- Luminaire efficacy*: 125 lm/W
- Colour Rendering Index min.: 80
- Correlated colour temperature*: 3000-4000 Kelvin
- Chromaticity tolerance (initial MacAdam): 5
- Rated median useful life*: L80 50000h at 25°C
- Ballast: 1x LED_Con
- Luminaire input power*: 16 W Power factor = 0.9
- Dimming: Fixed output
- Maintenance category CIE 97: D - Enclosed IP2X
- Total harmonic distortion (THD): 20.00 %

This product contains a light source of energy efficiency class E.

All values marked with an * are rated values. Connected electrical load and luminous flux are subject to an initial tolerance of +/- 10%, the most similar colour temperature is subject to an initial tolerance of +/- 150K. Unless stated otherwise, the values apply to an ambient temperature of 25°C.