

LED batten

A fast install and versatile IP20 batten with press release buttons for quick opening and installation. Reliable integrated LED technology, ensuring maintenance-free installation and a long lifetime. Homogeneous illumination. Direct replacement for conventional battens in terms of light performance and length. Piano-key terminals, enabling loop-in loop-out. ENEC certified driver. Body: sheet metal, white finish (RAL 9002). Diffuser: polycarbonate, opal. End caps: polycarbonate, white (RAL 9002). Weight: 1,4 kg

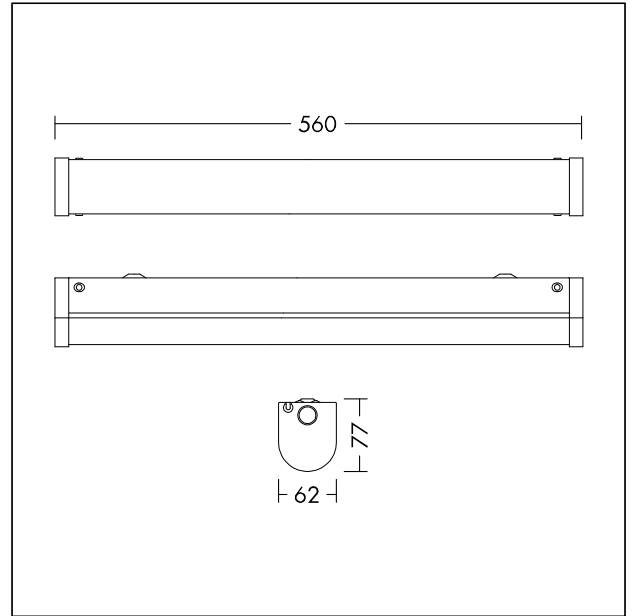

TE_POPPY_F_persp.jpg



TE_POPPY_M_600.wmf

Light Distribution

STD - standard

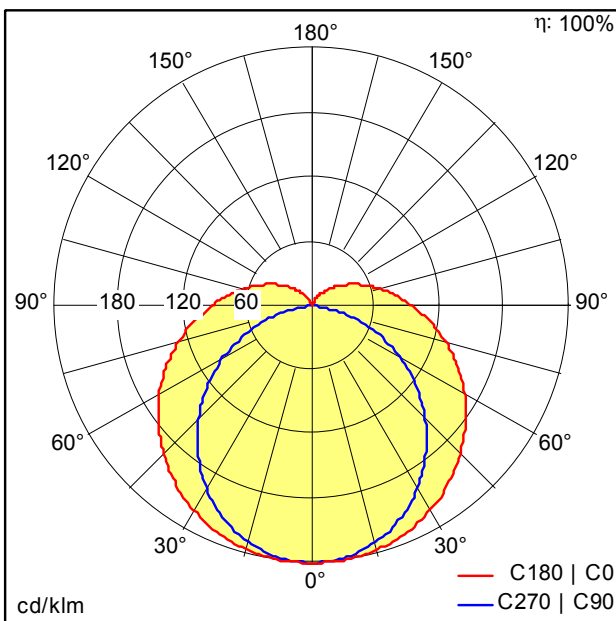

TE_POPPY_LED_600_2500_840.idt

- Light Source: LED
- Luminaire luminous flux*: 2500 lm
- Luminaire efficacy*: 104 lm/W
- Colour Rendering Index min.: 80
- Correlated colour temperature*: 4000 Kelvin
- Chromaticity tolerance (initial MacAdam): 5
- Rated median useful life*: L70 50000h at 25°C
- Ballast: 1x LED_Con
- Luminaire input power*: 24 W Power factor = 0.9
- Dimming: Fixed output
- Maintenance category CIE 97: D - Enclosed IP2X
- Total harmonic distortion (THD): 15.00 %

This product contains a light source of energy efficiency class E.

All values marked with an * are rated values. Connected electrical load and luminous flux are subject to an initial tolerance of +/- 10%, the most similar colour temperature is subject to an initial tolerance of +/- 150K. Unless stated otherwise, the values apply to an ambient temperature of 25°C.