

Areaflood Pro 2

Application versatile floodlight luminaire with best in class optical performance and connectivity solutions

- Full package product family of five luminaire sizes offering between 4,000 - 100,000 lumen outputs
- Integrating THORN's in-house designed and developed optic portfolio. Offering a total of 21 different light distributions covering area, road and sports applications
- Protecting Dark Skies and the nighttime environment, Areaflood Pro is available with THORN's Balanced White technology
- Designed with Dark Sky principals to limit light pollution, with 0 cd at 90° when mounted horizontally. Coupled with an accessory portfolio to further control light spill and light trespass
- Improving sustainability by managing energy consumption, Areaflood Pro is compatible with THORN's UrbaSens connectivity solutions for Outdoor lighting applications
- Maintenance free solution. Product lifetime up to 100,000HR L95
- 6kV as standard (integrated in the driver)
- 10kV optional (additional device - specify using myProduct)



Photographs, line drawings and photometric data are representative only. For specific product detail please select an individual product.

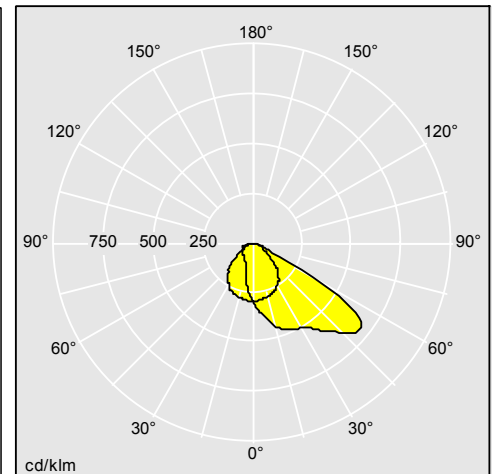
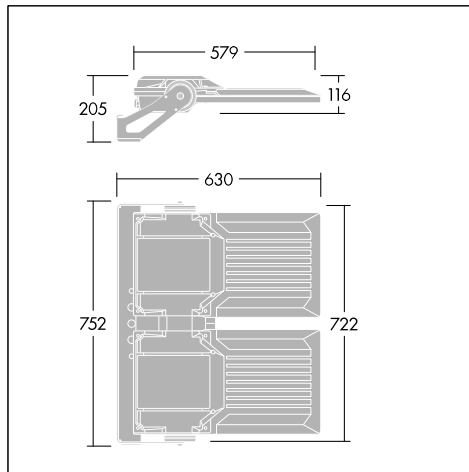

96635908

Material/Finish

Luminaire body manufactured in die-cast aluminium EN AC-44300

Robust solution with excellent corrosion resistance of C5 according to ISO 9223:2012

Finished in light grey (close to RAL9006) with an additional 50 RAL finishes available on request

Toughened Glass

High mechanical resistance of IK08 and IP66

Optional special surface treatment for installation in swimming pool applications can be specified using myProduct configurator

Installation/Mounting

Versatile adjustable surface mounting stirrup bracket to suit application demands, for wall, floor or column mounting

Optional spigot adapter accessory for post top mounting applications for Small, Medium and Large sizes (not double sizes)

Areaflood Pro 2

Specification

To specify state:

Family of versatile floodlights for area, road and sports lighting applications

Available in Electrical Class I and Class II

Zhaga Up and Zhaga Down sockets available

Integral NEMA and photocell available

DALI dimmable on-board driver variants

Bi-power Line and Light Reduction Twin Phase variants

Built in surge protection, with additional surge protection option available

CCT: 277 / 827 / 730 / 830 / 740 / 840 / 757 / 857

CCT: 957 TLCI 86 / 957 TLCI 90 for performance television broadcasting applications

Balanced white: CCT range 827 - 857

As Thorn Areaflood Pro 2

Ordering Guide

Description	ILCOS Code	Socket	Wt (kg)	SAP Code
Areaflood Pro 2, Small				
AFP2 S 24L35-740 A4 CL2 GY	LED		6,785	96635869
AFP2 S 24L50-740 A4 CL2 GY	LED		6,785	96635870
AFP2 S 24L70-740 A4 CL2 GY	LED		6,785	96635871
AFP2 S 36L35-740 A4 CL2 GY	LED		6,845	96635872
AFP2 S 36L50-740 A4 CL2 GY	LED		6,82	96635873
AFP2 S 36L70-740 A4 CL2 GY	LED		7,07	96635874
AFP2 S 48L35-740 A4 CL2 GY	LED		7,13	96635875
AFP2 S 48L50-740 A4 CL2 GY	LED		7,38	96635876
AFP2 S 48L70-740 A4 CL2 GY	LED		7,6	96635877
AFP2 S 24L35-740 A4 CL1 GY	LED		6,785	96635899
AFP2 S 24L50-740 A4 CL1 GY	LED		6,785	96635900
AFP2 S 24L70-740 A4 CL1 GY	LED		6,785	96635901
AFP2 S 36L35-740 A4 CL1 GY	LED		6,845	96635902
AFP2 S 36L50-740 A4 CL1 GY	LED		6,82	96635903
AFP2 S 36L70-740 A4 CL1 GY	LED		7,07	96635904
AFP2 S 48L35-740 A4 CL1 GY	LED		7,13	96635905
AFP2 S 48L50-740 A4 CL1 GY	LED		7,38	96635906
AFP2 S 48L70-740 A4 CL1 GY	LED		7,6	96635907
Areaflood Pro 2, Medium				
AFP2 M 60L35-740 A4 CL2 GY	LED		9,79	96635878
AFP2 M 60L50-740 A4 CL2 GY	LED		9,79	96635879
AFP2 M 60L70-740 A4 CL2 GY	LED		9,79	96635880
AFP2 M 72L35-740 A4 CL2 GY	LED		9,85	96635881
AFP2 M 72L50-740 A4 CL2 GY	LED		9,85	96635882
AFP2 M 72L70-740 A4 CL2 GY	LED		9,768	96635883
AFP2 M 96L35-740 A4 CL2 GY	LED		9,888	96635884
AFP2 M 96L50-740 A4 CL2 GY	LED		9,888	96635885
AFP2 M 96L70-740 A4 CL2 GY	LED		10,1	96635886
AFP2 M 96L85-740 A4 CL2 GY	LED		10,57	96635887
AFP2 M 60L35-740 A4 CL1 GY	LED		9,79	96635908
AFP2 M 60L50-740 A4 CL1 GY	LED		9,79	96635909
AFP2 M 60L70-740 A4 CL1 GY	LED		9,79	96635910

Areaflood Pro 2

Description	ILCOS Code	Socket	Wt (kg)	SAP Code
AFP2 M 72L35-740 A4 CL1 GY	LED		9,85	96635911
AFP2 M 72L50-740 A4 CL1 GY	LED		9,85	96635912
AFP2 M 72L70-740 A4 CL1 GY	LED		9,768	96635913
AFP2 M 96L35-740 A4 CL1 GY	LED		9,888	96635914
AFP2 M 96L50-740 A4 CL1 GY	LED		9,888	96635915
AFP2 M 96L70-740 A4 CL1 GY	LED		10,1	96635916
AFP2 M 96L85-740 A4 CL1 GY	LED		10,57	96635917
AFP2 M 96L70 740 A4 H CLO BS 3525 SP ->	LED		10,808	92998082

Areaflood Pro 2, Large

AFP2 L 108L35-740 A4 CL2 GY	LED		12,508	96635888
AFP2 L 108L50-740 A4 CL2 GY	LED		12,508	96635889
AFP2 L 108L70-740 A4 CL2 GY	LED		12,978	96635890
AFP2 L 120L35-740 A4 CL2 GY	LED		12,568	96635891
AFP2 L 120L50-740 A4 CL2 GY	LED		12,81	96635892
AFP2 L 120L70-740 A4 CL2 GY	LED		13,28	96635893
AFP2 L 144L35-740 A4 CL2 GY	LED		13,4	96635894
AFP2 L 144L50-740 A4 CL2 GY	LED		13,4	96635895
AFP2 L 144L70-740 A4 CL2 GY	LED		13,476	96635896
AFP2 L 144L80-740 A4 CL2 GY	LED		13,9	96635897
AFP2 L 108L35-740 A4 CL1 GY	LED		12,508	96635918
AFP2 L 108L50-740 A4 CL1 GY	LED		12,508	96635919
AFP2 L 108L70-740 A4 CL1 GY	LED		12,978	96635920
AFP2 L 120L35-740 A4 CL1 GY	LED		12,568	96635921
AFP2 L 120L50-740 A4 CL1 GY	LED		12,81	96635922
AFP2 L 120L70-740 A4 CL1 GY	LED		13,28	96635923
AFP2 L 144L35-740 A4 CL1 GY	LED		13,4	96635924
AFP2 L 144L50-740 A4 CL1 GY	LED		13,4	96635925
AFP2 L 144L70-740 A4 CL1 GY	LED		13,476	96635926
AFP2 L 144L80-740 A4 CL1 GY	LED		13,9	96635927
AFP2 L 144L70 740 A4 CL2 GY	LED		13,476	92994735
AFP2 L 144L70 740 A5 H CLO BS 3525 SP ->	LED		14,184	92998080
AFP2 L 144L70 740 A4 H CLO BS 3525 SP ->	LED		14,184	92998081

Areaflood Pro 2, Medium double

AFP2 2M 192L70-740 A4 CL2 GY	LED		23,78	96635898
AFP2 2M 192L70-740 A4 CL1 GY	LED		23,48	96635928
AFP2 2M 192L85-740 A4 CL1 GY	LED		24,45	96635929
AFP2 2M 192L50-740 A4 CL2 GY	LED		23,356	96636355
AFP2 2M 192L50-740 A4 CL1 GY	LED		23,056	96636356

Areaflood Pro 2, Large double

AFP2 2L 216L70-740 A4 CL1 GY	LED		28,74	96635930
AFP2 2L 288L70-740 A4 CL1 GY	LED		29,1	96635931
AFP2 2L 288L75-740 A4 CL1 GY	LED		29,222	96635932
AFP2 2L 216L50-740 A4 CL1 GY	LED		28,104	96636357
AFP2 2L 288L50-740 A4 CL1 GY	LED		28,464	96636358

Areaflood Pro 2, accessories

Areaflood Pro 2

Description	ILCOS Code	Socket	Wt (kg)	SAP Code
AFP MTP 76MM R9006			1,6	96274659
AFP MTP 60MM R9006			1,66	96274660
AFP MTP 60MM GY			1,77	96631743
AFP MTP 76MM GY			1,71	96631744
ACCESSORY DALI IN/OUT JUNCTION BOX			0,52	96631877
AFP2 BIRD DETERRENT SMALL			1,38	96636416
AFP2 BIRD DETERRENT MEDIUM			1,87	96636417
AFP2 AIMING DEVICE			0,392	96636419
AFP2 BIRD DETERRENT LARGE			2,08	96636422
AFP2 EXTERNAL LOUVERS SMALL			1,238	96636424
AFP2 EXTERNAL LOUVERS MEDIUM			1,348	96636425
AFP2 EXTERNAL LOUVERS LARGE			1,648	96636426